



CONSEIL

## ISOPRO® Liner

**ADP Conseil has developed a system to protect thermo-sensitive products for a period up to 48 hours: the range ISOPRO®.**

These packages are made in ISOPRO®, a double sided metalized extruded closed cell foam of 35 kg / m3.

This Liner, delivered in flat, allows you to **transform a simple cardboard box in isothermal packaging.**

ISOPRO® liners are for the Agro-alimentary sector as part of the shipment of fresh produces in e-business.

They are supplied in kit including:

- An ISOPRO® liner
- A carton box
- Ice packs
  - « Positive » cold for living products.
  - « 0°C » cold for processed food products.

The insulated liner slips into its box **with HAUT – BAS – FRAGILE in red**, ensuring the proper disposal of the ISOPRO® liner and ice packs during transport.

The offer comes in 5 standard sizes with the ability to perform semi-custom liner (from 500 skins) or liners specifically tailored to your cartons boxes from 5000 m2 transformed ISOPRO® foam.

This package takes up very little space for the storage (a 600 x 560 x 660 carton box contains between 70 and 125 liners to match the size / for the 28L, a box can hold up to 170 skins)  
The formatting is simply. It can be reused up to 8 times.

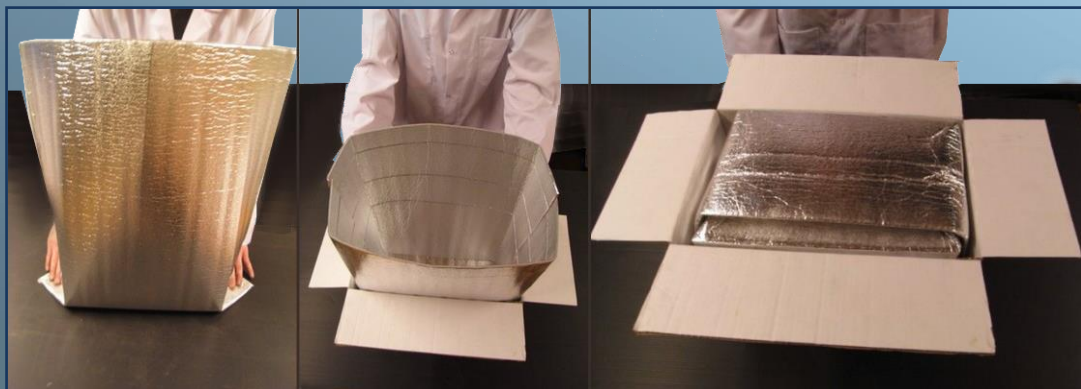

### **Technical Specifications:**

The ISOPRO® liner is made from ISOPRO® foam (extruded closed cell foam of 35 kg / m<sup>3</sup> density) with external and internal metallization. The external metallization allows an optimal reflection of the calories coming from the environment and internal metallization allows the reflection of the cold inside the liner. Between these two metallization, a closed cell foam is used to delay the input of calories. The sealing of the packaging is achieved through a double fold closing.

**This 3 mm foam is equivalent to 24 mm of expanded polystyrene.**

### **Using:**

This insulated packaging is designed to protect thermo-sensitive products in the Express courier shipments for 48 hours maximum, respecting the proper ice packs charges, when its equipped with our Eutectic liquid "Positive cold" (restitution tray at + 0.3 ° C) for live food or when its equipped with our special agro packs (restitution tray at -1/-2°C) for processed food products.

### **The ISOPRO® liner, ISTA 3A certified and UPS Transport :**

Our ISOPRO® liner is certified ISTA 3A. This is a performance simulation test or more precisely a laboratory simulation of mechanical transport.

The ISOPRO® liner spent the following tests:

- Climate preconditioning
- 1st drops / shocks test
- Random vibration with compressive load of 70 kg
- 2nd drops / shocks test
- Random vibration without compression load.

Our ISOPRO® liners have been certified by UPS Transport following the validation ISTA 3A..



### **The ISOPRO® liners are validated with the AFNOR NF-S 99-700**

Our ISOPRO® liners are validated with the AFNOR NF-S 99-700 for the desired duration of protection for your sensitive products.



**Configurations:**

The configurations of eutectic loads are adapted according to:

- The nature of the product (density, thermal sensitivity of the product ...)
- The mode of transport
- The cycle...

**6L ISOPRO® liner**

**Size 200 x 150 x 220 m/m**

**We recommend for optimal protection of your products for a period of 24 hours:**

Winter cycle: one 750cc Ice Pack on the top.

Summer cycle: one 750cc Ice Pack on the top & one 750cc ice pack below, depending on the unit densities of the products to be protect.

**Winter cycle**

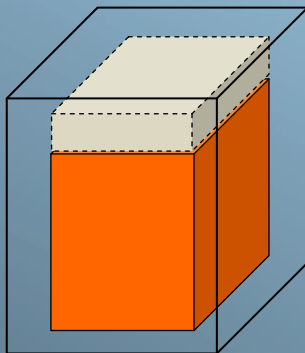

**Summer cycle**

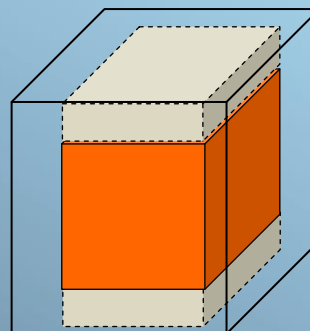

Product to be protected

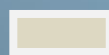

Ice Pack



**7.5L ISOPRO® liner**

**Size 220 x 210 x 170 m/m**

**We recommend for optimal protection of your products for a period of 24 hours:**

Winter cycle: two 750cc Ice Pack on the top.

Summer cycle: two 750cc Ice Pack on the top and two 750cc Ice packs below, depending on the unit densities of the products to be protect.

**Winter cycle**

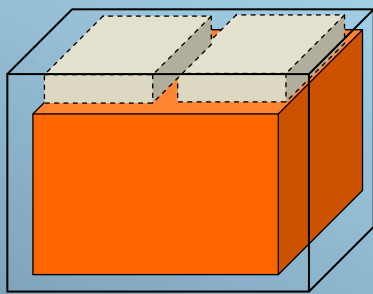

**Summer cycle**

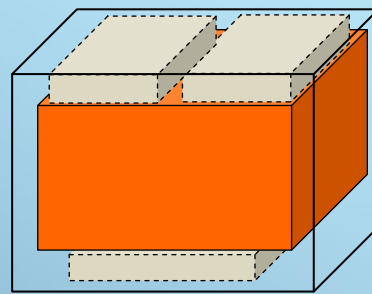

 Product to be protected

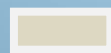
 Ice Pack

**15L ISOPRO®liner :**

**Size 300 x 250 x 200 m/m**

**We recommend for optimal protection of your products for a period of 24 hours:**

Winter cycle: three 750cc Ice Pack on the top.

Summer cycle: three 750cc Ice Pack on the top & and three Ice packs below, depending on the unit densities of the products to be protect.

**Winter cycle**

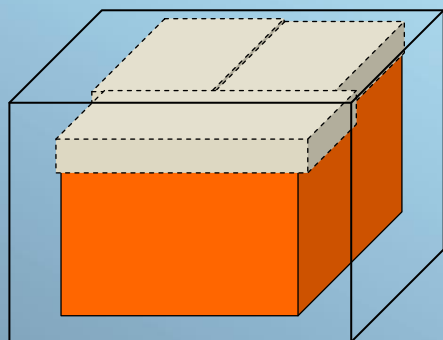

**Summer cycle**

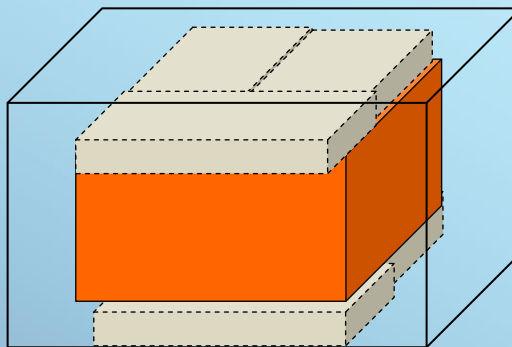

Product to be protected

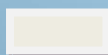

Ice Pack



CONSEIL



**Habillage ISOPRO® 21L**

**Format 350 x 200 x 300 m/m**

**We recommend for optimal protection of your products for a period of 24 hours:**

Winter cycle: three 750 cc ice packs on the top & one 750 cc ice pack below

Summer cycle: three 750cc Ice Pack on the top & and three Ice packs below, depending on the unit densities of the products to be protected.

**Winter cycle**

**Summer cycle**

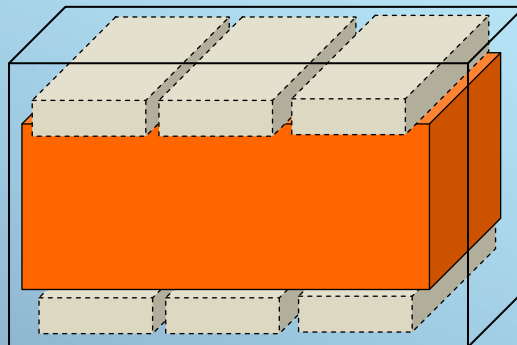
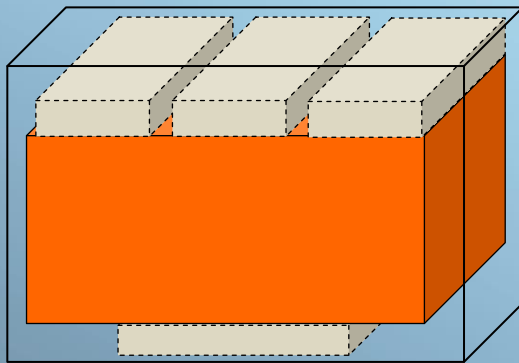

 Product to be protected

 Ice Pack

**28L ISOPRO® Liner:**

**Size 350 x 270 x 300 m/m**

**We recommend for optimal protection of your products for a period of 24 hours:**

Winter cycle: three 750 cc ice packs on the top & two 750 cc ice pack below.

Summer cycle: three 750cc Ice Pack on the top & and three Ice packs below, depending on the unit densities of the products to be protect.

**Winter cycle**

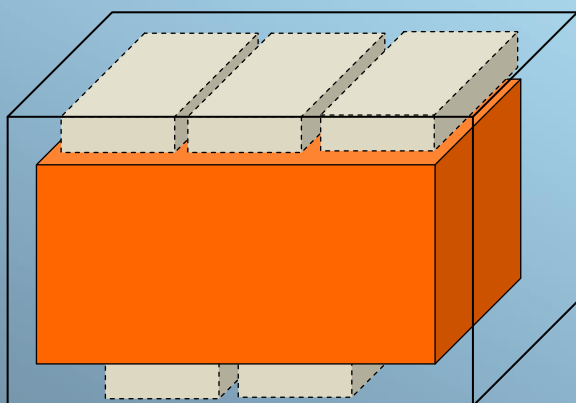

**Summer cycle**

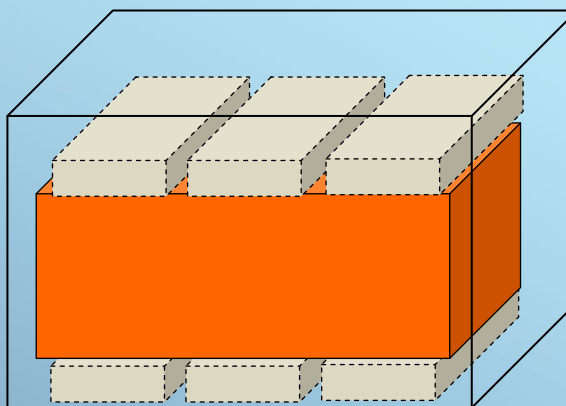

 Product to be protected

 Ice Pack



**41L ISOPRO® Liner:**

**Size 570 x 270 x 270 m/m**

**We recommend for optimal protection of your products for a period of 24 hours:**

Winter cycle: five 750CC ice packs on the top

Summer cycle: five 750CC ice packs on the top & five 750CC ice packs below,  
depending on the unit densities of the products to be protected.

**Winter cycle**

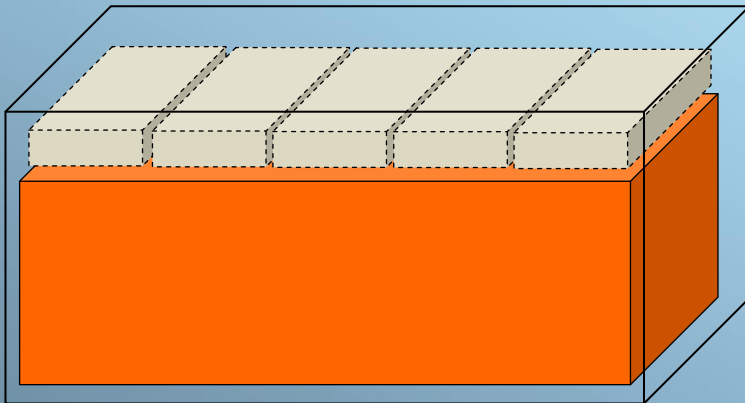

**Summer cycle**

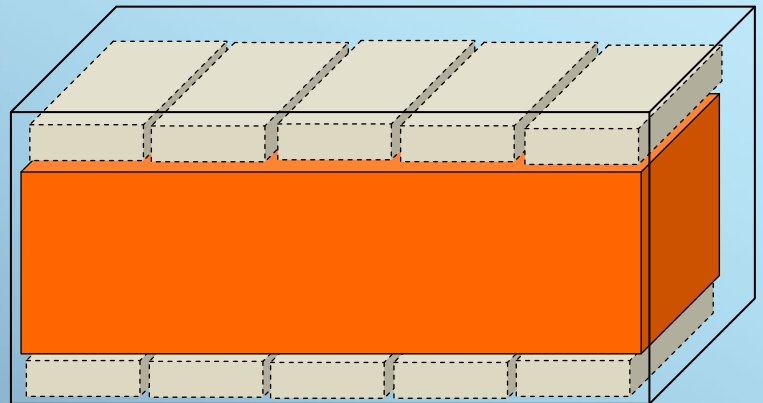

Product to be protected

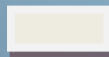

Ice Pack



## Sizes :

Flat size	Volume Size
350 x 490 m/m	200 x 150 x 220 m/m - 6 L
430 x 530 m/m	220 x 210 x 170 m/m - 7,5 L
550 x 560 m/m	300 x 250 x 200 m/m - 15 L
550 x 650 m/m	350 x 200 x 300 m/m - 21 L
620 x 750 m/m	350 x 270 x 300 m/m - 28 L
870 x 720 m/m	570 x 270 x 270 m/m - 41 L

## It is possible to adapt the format to your needs:

- Semi custom: the size of the width whether the addition of the length and width must match one of our 3 standard widths, whether 330 m / m, 350 m / m, 550 m / m or 620 m / m. You have no limit on the size of the pitch.
- Custom made: it must be extruded 5000m<sup>2</sup> of foam.

## Quantities:

Size	Minimal Quantity
200 x 150 x 220 m/m	1 carton box whether 125 liners
220 x 210 x 170 m/m	1 carton box whether 110 liners
300 x 250 x 200 m/m	1 carton box whether 85 liners
350 x 200 x 300 m/m	1 carton box whether 70 liners
350 x 270 x 300 m/m	1 box whether 170 liners
570 x 270 x 270 m/m	1 box whether 170 liners
Semi custom	500 liners
Custom made	5000m <sup>2</sup> extruded foam



CONSEIL



**Weight:**

Volume	Foam	Aluminium	Total Weight
6 Liters	47 gr	20 gr	67 gr
7,5 Liters	49 gr	23 gr	72 gr
15 Liters	94 gr	26 gr	120 gr
21 Liters	107 gr	30 gr	137 gr
28 Liters	109 gr	35 gr	144 gr
41 Liters	150 gr	37 gr	187 gr

**Delay:**

For standard widths, it takes 4-5 weeks after 8 weeks on the custom made.